

La riproduzione del contenuto del presente documento, non espressamente autorizzata dalla Rubinetterie Fratelli Crevola snc, verrà perseguita secondo le norme di legge vigenti. Tutti i diritti riservati nel caso di rilascio di brevetto o di deposito d'un modello d'uso.

Copying of this document, and giving it to others and the use or communication of the contents thereof, are forbidden without express authority of Rubinetterie Fratelli Crevola snc. Offenders are liable to the payment of damages. All rights are reserved in the event of the grant of a patent or the registration of a utility model or design.

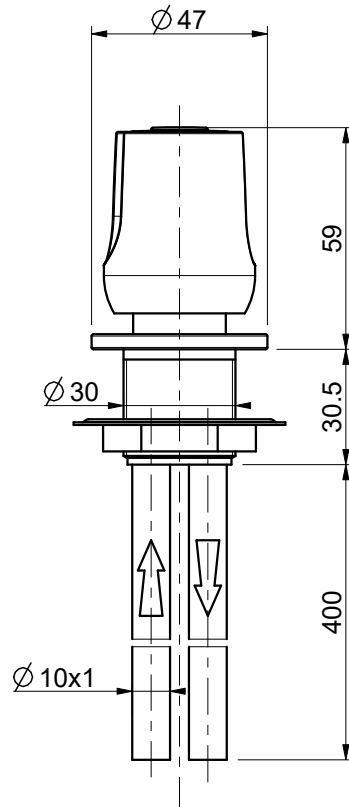

Data Revisione: 17-02-2025	Rev.: 1.1
Scala: 3:2	Peso (Gr.): 483.8

CO 3040

Comando

